

AHU Controller Specifications

1. Application

This controller is used to set up a system by connecting a field-supplied Air Handling Unit (AHU) to Mitsubishi Electric City Multi outdoor unit.

Applicable models: PAC-AH125, 140, 250, and 500M-J

2. System restrictions and use of range

(1) System configuration

Connectable outdoor units	PUHY-P250,300,350,400,450,500YGM-A, PUHY-P*Y(S)HM-A, PUHY-P*Y(S)JM-A, PUHY-EP*Y(S)HM-A, PUHY-EP*Y(S)JM-A, PUHY-HP*Y(S)HM-A, PUHY-RP*Y(S)JM-A, PQHY-P*Y(S)HM-A, PURY-P*Y(S)HM-A, PURY-P*Y(S)JM-A, PURY-EP*Y(S)HM-A, PURY-EP*Y(S)JM-A, PURY-RP*Y(S)JM-A, PQRY-P*Y(S)HM-A *PAC-AH500M-J can NOT be connected to PURY and PQRY.
Refrigerant type	R410A
Capacity of connectable AHU units and indoor units	80~100% of outdoor unit capacity

*Air flow rate is limited to the table shown in 4(1) when AHU is connected with standard indoor units.

(2) Operating conditions

[PUHY and PURY Series]

Operating conditions of indoor, outdoor, air handling units (cooling/heating)

Unit Type	Cooling	Heating
AHU (Heat exchanger inlet air temperature)	15~24°CWB	-10~15 DB(Discharge air temp. control)* -10~20 DB(Suction/return air temp. control)
Outdoor unit	refer to the specifications of outdoor unit	

*Discharge air temperature would be unstable when the inlet air temperature is more than 15 .

[PQHY and PQRY Series]

Operating conditions of indoor, inlet water, air handling units (cooling/heating)

Unit Type	Cooling	Heating
AHU (Heat exchanger inlet air temperature)	15~24°CWB	5~15 DB(Discharge air temp. control)* 5~20 DB(Suction/return air temp. control)
Inlet water temperature	10~45°C	10~45°C

*Discharge air temperature would be unstable when the inlet air temperature is more than 15 .

(3) Refrigerant pipe size, pipe length, and height difference restrictions

Model names	Unit capacity	Pipe size(Liquid / Gas)
PAC-AH125M-J PAC-AH140M-J	100, 125, 140	Φ9.52 / Φ15.88
PAC-AH250M-J	200	Φ9.52 / Φ19.05
	250	Φ9.52 / Φ22.2
PAC-AH500M-J	400	Φ12.7/ Φ28.58
	500	Φ15.88 / Φ28.58

Pipe length Height difference	Refer to the technical data book of the outdoor unit.
Amount of refrigerant to be added	Refer to the technical data book of the outdoor unit.

3. Product configuration

(1) Series configuration

Several types of controllers to accommodate different AHU capacities are available.

Select the appropriate controller.

Model name		PAC-AH125M-J	PAC-AH140M-J	PAC-AH250M-J	PAC-AH500M-J			
Cooling	Max. capacity (kW)	11.2	14.0	16.0	22.4	28.0	45.0	56.0
	Min. capacity (kW)	9.0	11.2	14.0	16.0	22.4	36.0	45.0
Heating	Max. capacity (kW)	12.5	16.0	18.0	25.0	31.5	50.0	63.0
	Min. capacity (kW)	10.0	12.5	16.0	18.0	25.0	40.0	50.0
Reference air flow rate (m ³ /h)		2000	2500	3000	4000	5000	8000	10000
Unit capacity		100	125	140	200	250	400	500

- * Calculate the capacity of connectable indoor units using the "Unit capacity" in the table above.
The Unit capacity is set at the model name at factory shipment. Change the Unit capacity to the appropriate value for the selected controller using the switch on the controller board. When it is needed, refer to the installation manual for how to change the Unit capacity.
- * Refer to the technical data book of the outdoor unit about the actual capacity.

(2) Controller components

Name		Usage
Controller	Controller board	For operation control
	Transformer	For controller board
	Terminal block	For power source, for external I/O, for internal and external communication, for remote controller, and for thermistor
	Connector	For remote controller and for level input switch
	Relay	For operation display and for error display
LEV-kit		Electronic linear expan. valve
Thermistor		For detection of suction air temperature, discharge temperature, liquid pipe temperature, and gas pipe temperature
Clip		For mounting suction air and discharge air temperature thermistor
Insulation		For insulating liquid pipe and gas pipe thermistor
Tie band		For fixing liquid pipe and gas pipe thermistor
Tube		For fixing wiring
Installation manual		-

(3) Major specifications

Power supply		220~240V 50/60Hz											
External dimension (mm)		378(420)×328×104(122) The figure in () indicates mounting's.											
Net weight (kg)		5											
External finish(Munsel No.)		Galvanized steel											
IP-class		IP2X											
Remote controller temperature setting range	Cooling	14~30°C											
	Heating	17~28°C											
	Auto	17~28°C											
Operation	Operation by optional remote controller	<p>Press ON/OFF button on the remote controller to start/stop the operation. Following setting can be done by optional remote controller(PAR-21MAA):</p> <p>1)Temperature setting Discharge air temperature setting or Suction air temperature setting are available by DIP switch setting. Please refer to "Switch function" in detail.</p> <p>2)Operation mode setting Please refer to the operation manual of the remote controller in detail.</p> <p>*Remove the attached connector "CNRM" in case the optional remote controller is used for its operation.</p>											
	ON/OFF Operation by external input*	<p>Connect the field-installed external thermostat (ON/OFF) to the external input (SW1:ON/OFF) to start the operation when the external thermo is ON, and stop the operation when it is OFF.</p> <p>*Set the attached connector "CNRM" in case the external input is used for ON/OFF operation.</p>											
	Setting temperature by external input	<p>Discharge air temperature setting or suction air temperature setting can be done by analog input (0-10V) accordingly (Analog input operation).</p> <p>Setting from remote controller is not available when analog input setting is used. (Either remote controller setting or analog input operation is selected.)</p> <p>Do not operate the system controller when analog input setting is used. It would cause conflicting operation with analog input operation and unit would not operate in good working order.</p> <p>< Setting > Set the DIP switch 8-2 ON when Analog input operation is used.</p> <table border="1"> <tr> <td>SW8-2</td> <td>Analog input</td> </tr> <tr> <td>OFF</td> <td>NOT effective (initial setting)</td> </tr> <tr> <td>ON</td> <td>Effective</td> </tr> </table> <p>When the discharge air temperature control mode is selected, lower limit setting of the discharge air temperature in cooling mode is chosen as below table,</p> <table border="1"> <tr> <td>SW3-5</td> <td>Lower limit setting temperature</td> </tr> <tr> <td>OFF</td> <td>14 (Initial setting)</td> </tr> <tr> <td>ON</td> <td>8</td> </tr> </table>	SW8-2	Analog input	OFF	NOT effective (initial setting)	ON	Effective	SW3-5	Lower limit setting temperature	OFF	14 (Initial setting)	ON
SW8-2	Analog input												
OFF	NOT effective (initial setting)												
ON	Effective												
SW3-5	Lower limit setting temperature												
OFF	14 (Initial setting)												
ON	8												

Setting temperature by analog input (0-10V) operation is chosen as below setting (Type1 or Type2).

SW8-3	Analog input type	Restriction
OFF	Type1 (Initial setting)	Auto mode is available
ON	Type2	Auto mode is NOT available

i) Type1 <For temperature control>

Cooling/Heating

-Setting temperature = $2.5 \times \text{Ain} + 5.0$: *Ain=Input Voltage

-Condition

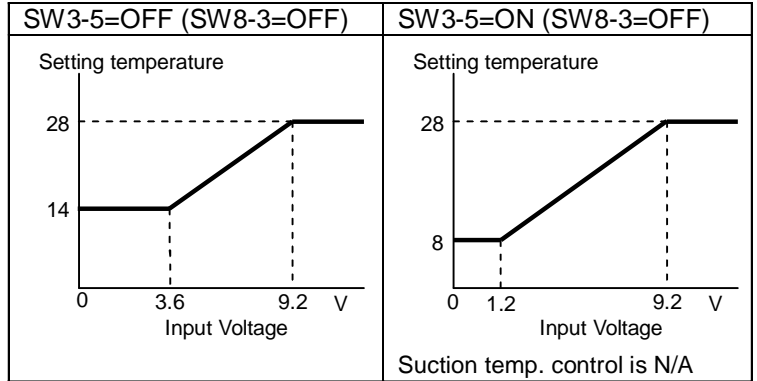

*When the setting temperature in heating mode is 17 or less, the discharge air temperature can be unstable.

ii) Type2 <For capacity control>

Cooling

-Setting temperature = $-2.5 \times \text{Ain} + 31$: *Ain=Input Voltage

-Condition

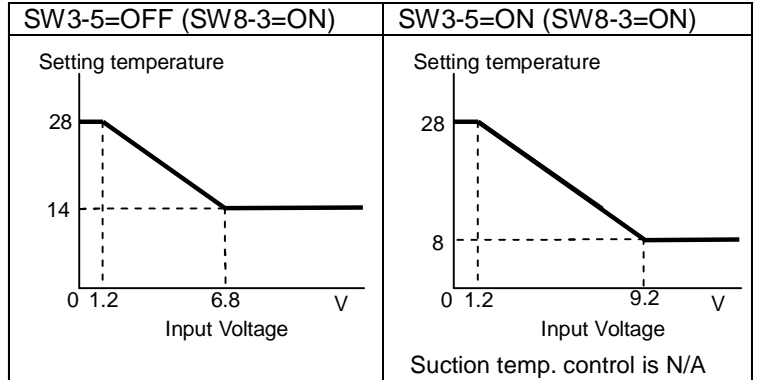

Heating

-Setting temperature = $2.5 \times \text{Ain} + 5.0$: *Ain=Input Voltage

-Condition

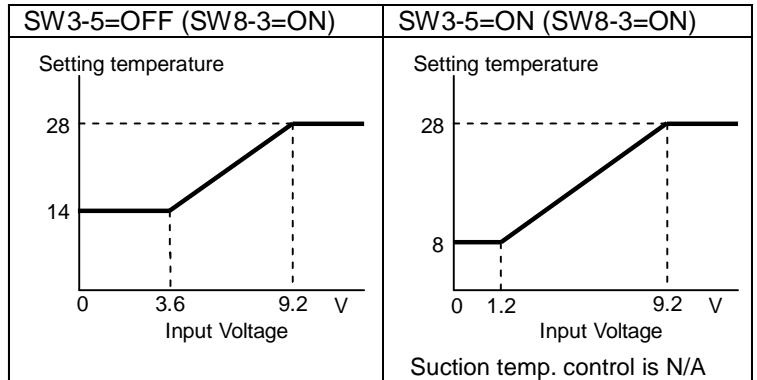

*When the setting temperature in heating mode is 17 or less, the discharge air temperature can be unstable.

*Setting temperature is updated when the voltage variation of 0.2V or more is detected for 1 sec or more.

	Contact input	<p>Following functions can be controlled from local controller by using MAC-3971F-E.</p> <ul style="list-style-type: none"> -External control (ON/OFF) -External output (ON/OFF, Error) -Mode select(Cooling/Heating) -Setting temperature <p>Refer to the installation manual of MAC-3971F-E about details.</p>
	Interlock operation with AHU fan	<p>Interlock setting between the error stop of AHU fan and the external error input must be made to close the LEV of AHU heat exchanger when AHU fan makes an error stop. Refer to section 5 for details.</p>
Temperature control	Temperature control by optional remote controller	<p>Discharge air temperature control or suction/room air temperature control can be chosen by changing the switch on control board and by changing the position of attached thermistor.</p> <p>In controlling the discharge air temperature, the capacity is controlled so that detection temperature of the thermistor installed in an outlet of AHU reaches the set temperature by remote controller.</p> <p>In controlling the suction/room air temperature, the capacity is controlled so that thermostat becomes OFF if detection temperature of the thermistor installed in an inlet of AHU or the room reaches the set temperature by remote controller.</p>

Temperature control	Temperature control by optional remote controller	<p>(i) Thermostat condition in controlling the discharge air temperature</p> <p>TH21: Discharge air temperature TH24: Suction air temperature To : The preset temperature on the remote controller *The value shown with a square in the table below can be changed by a dip-switch.</p> <p>Cooling</p> <table border="1" data-bbox="694 465 1453 757"> <tr> <td>The range of "To"</td> <td>14 ~ 30</td> </tr> <tr> <td>Thermostat OFF a) or b) or c)</td> <td>a) TH24 < To b) TH24 < 14 c) TH21 < To - 2 is continued for 10 minutes.</td> </tr> <tr> <td>Thermostat ON a) & b) & c) & d)</td> <td>a) TH24 > To + 1 b) TH24 > 15 c) TH21 > To + 1 d) It passes from thermostat OFF for 3 minutes.</td> </tr> </table> <p>Heating</p> <table border="1" data-bbox="694 819 1453 1111"> <tr> <td>The range of "To"</td> <td>17 ~ 28</td> </tr> <tr> <td>Thermostat OFF a) or b) or c)</td> <td>a) TH24 > To b) TH24 > 15 c) TH21 > To + 3 is continued for 10 minutes.</td> </tr> <tr> <td>Thermostat ON a) & b) & c) & d)</td> <td>a) TH24 < To - 1 b) TH24 < 14 c) TH21 < To - 1 d) It passes from thermostat OFF for 3 minutes.</td> </tr> </table> <p>(ii) Thermostat condition in controlling the suction/return air temperature</p> <p>TH21: Suction/Return air temperature TH24: Suction air temperature To : The preset temperature on the remote controller *The value shown with a square in the table below can be changed by a dip-switch.</p> <p>Cooling</p> <table border="1" data-bbox="694 1429 1453 1688"> <tr> <td>The range of "To"</td> <td>14 ~ 30</td> </tr> <tr> <td>Thermostat OFF a) or b)</td> <td>a) TH24 < 20 b) TH21 < To - 0.5</td> </tr> <tr> <td>Thermostat ON a) & b) & c)</td> <td>a) TH24 > 21 b) TH21 > To + 0.5 c) It passes from thermostat OFF for 3 minutes.</td> </tr> </table> <p>Heating</p> <table border="1" data-bbox="694 1751 1453 1886"> <tr> <td>The range of "To"</td> <td>17 ~ 28</td> </tr> <tr> <td>Thermostat OFF</td> <td>a) TH24 > 21 b) TH21 > To</td> </tr> </table>	The range of "To"	14 ~ 30	Thermostat OFF a) or b) or c)	a) TH24 < To b) TH24 < 14 c) TH21 < To - 2 is continued for 10 minutes.	Thermostat ON a) & b) & c) & d)	a) TH24 > To + 1 b) TH24 > 15 c) TH21 > To + 1 d) It passes from thermostat OFF for 3 minutes.	The range of "To"	17 ~ 28	Thermostat OFF a) or b) or c)	a) TH24 > To b) TH24 > 15 c) TH21 > To + 3 is continued for 10 minutes.	Thermostat ON a) & b) & c) & d)	a) TH24 < To - 1 b) TH24 < 14 c) TH21 < To - 1 d) It passes from thermostat OFF for 3 minutes.	The range of "To"	14 ~ 30	Thermostat OFF a) or b)	a) TH24 < 20 b) TH21 < To - 0.5	Thermostat ON a) & b) & c)	a) TH24 > 21 b) TH21 > To + 0.5 c) It passes from thermostat OFF for 3 minutes.	The range of "To"	17 ~ 28	Thermostat OFF	a) TH24 > 21 b) TH21 > To
The range of "To"	14 ~ 30																							
Thermostat OFF a) or b) or c)	a) TH24 < To b) TH24 < 14 c) TH21 < To - 2 is continued for 10 minutes.																							
Thermostat ON a) & b) & c) & d)	a) TH24 > To + 1 b) TH24 > 15 c) TH21 > To + 1 d) It passes from thermostat OFF for 3 minutes.																							
The range of "To"	17 ~ 28																							
Thermostat OFF a) or b) or c)	a) TH24 > To b) TH24 > 15 c) TH21 > To + 3 is continued for 10 minutes.																							
Thermostat ON a) & b) & c) & d)	a) TH24 < To - 1 b) TH24 < 14 c) TH21 < To - 1 d) It passes from thermostat OFF for 3 minutes.																							
The range of "To"	14 ~ 30																							
Thermostat OFF a) or b)	a) TH24 < 20 b) TH21 < To - 0.5																							
Thermostat ON a) & b) & c)	a) TH24 > 21 b) TH21 > To + 0.5 c) It passes from thermostat OFF for 3 minutes.																							
The range of "To"	17 ~ 28																							
Thermostat OFF	a) TH24 > 21 b) TH21 > To																							

	Temperature control by external thermostat	Connect the field-installed external thermostat (ON/OFF) to the external input (ON/OFF) to start the operation when the external thermo is ON, and stop the operation when it is OFF. The thermostat will be turned off when the suction air temperature thermistor reading reaches the preset temperature on the remote controller. Refer to section 5 for details. * A remote controller is necessary for the operation mode switching.
Protection function	Freezing prevention	After 16-minute or more cooling operation, and when 1°C or less of the thermistor detection temperature for liquid pipe is detected for 3 minutes in a row, the linear expansion valve will be closed to prevent freezing. The operation will be normal when either of the following conditions is met. <ul style="list-style-type: none"> - When 3 minutes have passed after 10°C or more of the thermistor detection temperature for liquid pipe is detected. - When 6 minutes have passed after the expansion valve was closed to prevent freezing.
	Sensor failure	If a short or an open of the thermistor is detected during operation, the error will affect the LEV, and it will be closed.
	Communication error	If the addresses overlap or the transmission line is not connected properly, the error will affect the LEV, and it will be closed.
	External error	Error stop (code:4109) is available by the interlock setting between local fan motor error output and external error input. Error stop (code:4109) is caused when the contact A11 and A12 opened, then both outdoor unit stops and fan stop its operation.
	Other types of error	If the outdoor unit in the system has a problem, it will affect the entire system, and the compressor will stop.

Switch function	Thermostat control	a) Change of discharge or suction air temperature control				
		Dip switch		Thermostat control	Remarks	
		SW7-2				
		OFF		Suction / return	-	
		ON		Discharge	Initial setting	
		b)TH21				
		Detection temperature of the thermistor TH21 is replaced to the value below by Dip switch on the control board.				
		Dip switch		Detection temperature	Remarks	
		SW1-2	SW1-3	Cooling	Heating	
		OFF	OFF	TH21	TH21	Initial setting
		ON	OFF	TH21-1	TH21+1	-
		OFF	ON	TH21-2	TH21+2	-
		ON	ON	TH21-3	TH21+3	-
		c)TH24				
		i) Discharge air temperature control				
		<Cooling>				
		Dip switch		Thermostat condition of TH24	Remarks	
		SW3-10		Thermo-OFF	Thermo-ON	
		OFF		14	15	Initial setting
		ON		20	21	-
		<Heating>				
		Dip switch		Thermostat condition of TH24	Remarks	
		SW3-8	SW3-9	Thermo-OFF	Thermo-ON	
		OFF	OFF	21	20	-
		ON	OFF	N/A	N/A	-
		OFF	ON	10	9	-
		ON	ON	15	14	Initial setting
		ii)Suction/return air temperature control				
		<Cooling>				
		Dip switch		Thermostat condition of TH24	Remarks	
		SW1-8		Thermo-OFF	Thermo-ON	
		OFF		20	21	Initial setting
		ON		15	16	-
		<Heating>				
		N/A				

d) Dip-switch for function

In a table shown below, the gray part shows "At delivery".

i) Discharge air temperature control

SW1

No.	Function	Operation by switch	
		ON	OFF
1	Thermistor< suction temperature> position	Remote controller	TH21
2	Replace of TH21 Cooling: TH21-a Heating: TH21+a	2 / 3 OFF/OFF: a=0 ON / OFF: a=1 OFF / ON: a=2 ON / ON: a=3	
3			
4	NOT available	N/A	Fix
5	Remote indication switching	Thermostat ON signal	Fan output
6	NOT available	N/A	Fix
7	NOT available	N/A	Fix
8	NOT available	N/A	Fix
9	Auto reset function	Effective	Not effective
10	Power ON/OFF	Effective	Not effective

SW3

No.	Function	Operation by switch																									
		ON	OFF																								
1	Heat pump /Cooling only	Cooling only	Heat pump																								
2	NOT available	N/A	Fix																								
3	NOT available	N/A	Fix																								
4	Fan in defrosting	Fan ON	Fan OFF																								
5	Lower limit of setting temp. for analog input or MA remote controller	8	14																								
6	NOT available	N/A	Fix																								
7	NOT available	N/A	Fix																								
8	Thermostat by TH24 in heating	<table border="1"> <thead> <tr> <th colspan="2">Dip switch</th> <th colspan="2">Thermo-</th> </tr> <tr> <th>3-8</th> <th>3-9</th> <th>OFF</th> <th>ON</th> </tr> </thead> <tbody> <tr> <td>OFF</td> <td>OFF</td> <td>21</td> <td>20</td> </tr> <tr> <td>ON</td> <td>OFF</td> <td>N/A</td> <td>N/A</td> </tr> <tr> <td>OFF</td> <td>ON</td> <td>10</td> <td>9</td> </tr> <tr> <td>ON</td> <td>ON</td> <td>15</td> <td>14</td> </tr> </tbody> </table>		Dip switch		Thermo-		3-8	3-9	OFF	ON	OFF	OFF	21	20	ON	OFF	N/A	N/A	OFF	ON	10	9	ON	ON	15	14
Dip switch		Thermo-																									
3-8		3-9	OFF	ON																							
OFF		OFF	21	20																							
ON	OFF	N/A	N/A																								
OFF	ON	10	9																								
ON	ON	15	14																								
9																											
10	Thermostat by TH24 in cooling	20 -OFF 21 -ON	14 -OFF 15 -ON																								

SW8

No.	Function	Operation by switch	
		ON	OFF
1	Demand input	Pulse	Level
2	Analog input	Effective	Not effective
3	Analog input type	Type2	Type1

ii) Suction/return air temperature control

SW1

No.	Function	Operation by switch	
		ON	OFF
1	Thermistor< suction temperature> position	Remote controller	TH21
2	Replace of TH21 Cooling: TH21-a Heating: TH21+a	2 / 3 OFF/OFF: a=0 ON / OFF: a=1 OFF / ON: a=2 ON / ON: a=3	
3			
4	NOT available	N/A	Fix
5	Remote indication switching	Thermostat ON signal indication	Fan output indication
6	NOT available	N/A	Fix
7	NOT available	N/A	Fix
8	Thermostat by TH24 in cooling	15 -OFF 16 -ON	20 -OFF 21 -ON
9	Auto reset function	Effective	Not effective
10	Power ON/OFF	Effective	Not effective

SW3			
No.	Function	Operation by switch	
		ON	OFF
1	Heat pump /Cooling only	Cooling only	Heat pump
2	NOT available	N/A	Fix
3	NOT available	N/A	Fix
4	Fan in defrosting	Fan ON	Fan OFF
5	NOT available	N/A	Fix
6	NOT available	N/A	Fix
7	NOT available	N/A	Fix
8	NOT available	Fix	N/A
9	NOT available	Fix	N/A
10	NOT available	Fix	N/A

SW8		
Function	Operation by switch	
	ON	OFF
Demand input	Pulse	Level
Analog input	Effective	Not effective
Analog input type	Type2	Type1

* Default setting (operation mode setting or temperature setting) with an optional remote controller must be made when an external input is used.

4. Requirements on AHU design

(1) Design method of heat exchanger

Model name		PAC-AH125M-J		PAC-AH140M-J		PAC-AH250M-J		PAC-AH500M-J																																																
Common part	Unit capacity	100	125	140	200	250	400	500																																																
	Reference air flow rate in case of connection without standard indoor units (m ³ /h)	2000	2500	3000	4000	5000	8000	10000																																																
	Max. air flow rate in case of connection with standard indoor units, except cooling only (m ³ /h)	800	1000	1120	1600	2000	3200	4000																																																
	Min. volume inside heat exchanger tube (cm ³)	1500	1900	2150	3000	3750	6000	7500																																																
	Max. volume inside heat exchanger tube (cm ³)	2850	3550	4050	5700	7100	11400	14200																																																
Cooling	Max. capacity (kW)	11.2	14.0	16.0	22.4	28.0	45.0	56.0																																																
	Min. capacity (kW)	9.0	11.2	14.0	16.0	22.4	36.0	45.0																																																
	Standard number of circuits (Heat exchanger tube size Φ9.52)	4~5	4~5	5~6	6~10	8~10	16~20	16~20																																																
	Pressure drop of the refrigerant in heat exchanger	Max. 0.03MPa																																																						
	LEV inlet temperature	25°C																																																						
	Evaporating temperature	8.5°C																																																						
	SH	5K																																																						
	Evaporator outlet Temperature	13.5°C																																																						
Evaporator suction air temperature	27°CDB/19°CWB																																																							
Heating	Max. capacity (kW)	12.5	16.0	18.0	25.0	31.5	50.0	63.0																																																
	Min. capacity (kW)	10.0	12.5	16.0	18.0	25.0	40.0	50.0																																																
	Condensing temperature =TC	Choose TC satisfying a condenser design condition among chart below depending on unit size. In the case of using a heat recovery, choose TC=48 as the suction temperature of heat exchanger may become 10 or more even if outdoor temperature is 0 .																																																						
		<p>Outdoor temp. 0 DB/-2.9 WB(Water temp. 20 in PQHY/PQRY)</p> <table border="1"> <thead> <tr> <th>Unit size</th> <th>800</th> <th>1200</th> <th>1600</th> <th>2000</th> <th>2400</th> </tr> </thead> <tbody> <tr> <td>P100</td> <td>800</td> <td>1200</td> <td>1600</td> <td>2000</td> <td>2400</td> </tr> <tr> <td>P125</td> <td>1000</td> <td>1500</td> <td>2000</td> <td>2500</td> <td>3000</td> </tr> <tr> <td>P140</td> <td>1120</td> <td>1680</td> <td>2240</td> <td>2800</td> <td>3360</td> </tr> <tr> <td>P200</td> <td>1600</td> <td>2400</td> <td>3200</td> <td>4000</td> <td>4800</td> </tr> <tr> <td>P250</td> <td>2000</td> <td>3000</td> <td>4000</td> <td>5000</td> <td>6000</td> </tr> <tr> <td>P400</td> <td>3200</td> <td>4800</td> <td>6400</td> <td>8000</td> <td>9600</td> </tr> <tr> <td>P500</td> <td>4000</td> <td>6000</td> <td>8000</td> <td>10000</td> <td>12000</td> </tr> </tbody> </table>								Unit size	800	1200	1600	2000	2400	P100	800	1200	1600	2000	2400	P125	1000	1500	2000	2500	3000	P140	1120	1680	2240	2800	3360	P200	1600	2400	3200	4000	4800	P250	2000	3000	4000	5000	6000	P400	3200	4800	6400	8000	9600	P500	4000	6000	8000	10000
Unit size	800	1200	1600	2000	2400																																																			
P100	800	1200	1600	2000	2400																																																			
P125	1000	1500	2000	2500	3000																																																			
P140	1120	1680	2240	2800	3360																																																			
P200	1600	2400	3200	4000	4800																																																			
P250	2000	3000	4000	5000	6000																																																			
P400	3200	4800	6400	8000	9600																																																			
P500	4000	6000	8000	10000	12000																																																			

* When air flow rate is less than the above, choose TC=48 .

Heating	HEX inlet temperature	Choose HEX inlet temperature from chart below depending on TC.
	SC	15K
	Condensor outlet temperature	TC-15
	Condensor suction air temperature	0 DB / -2.9 WB

*Calculate the capacity of connectable AHU units using the “Unit capacity” in the table above.

*Refer to the technical data book of the outdoor unit about the actual capacity.

(2) Heat exchanger manufacturing

Design pressure	4.15 MPa
Evaporator burst pressure Compressive strength	The compressive strength of the evaporator and of other pipes must exceed 12.45MPa. Insufficient withstand pressure may cause the pipes to crack and result in gas leakage.
Contamination control	Clean the heat exchanger with detergent to make the allowable level of contamination per unit length of the heat exchanger tube of the following values or less on the assumption that the heat exchanger tube size is $\Phi 9.52$. Do not use chlorinated detergent. Do not leave flux. Allowable level of contamination may cause the compressor not to function properly. Contamination amount: residual water amount 0.6 mg/m or less, residual oil amount 0.5 mg/m or less, amount of solid contaminants 1.8 mg/m or less

(3) Installation conditions of AHU controller

Installation site	<ul style="list-style-type: none"> - Avoid locations in direct sunlight. - Avoid locations exposed to the air out. - Avoid locations exposed to the elements or water splashes. - Avoid locations exposed to steam or oil vapor. - Avoid locations where combustible gas may leak, settle or generated - Avoid installation near machines emitting high-frequency waves. - Avoid places where acidic solutions are frequency waves. - Avoid places where sulfur-based or other sprays are frequently used. - Avoid places where vibration may occur.
Ambient temperature	-20~43°C
Ambient humidity	Relative humidity of 95% or less (No dew condensation is allowed)
Installation angle	Vertical installation

(4) Cautions for installing LEV-kit

Installation environment	Avoid locations in direct sunlight.
Installation angle	Install the motor above the horizontal.
Pipe size	Φ9.52 (Brazing) Use two(four) LEVs when installing AH250(AH500). Connect two(four) LEVs in parallel, and connect them to the appropriate refrigerant pipe according to the unit capacity.
Caution on brazing	LEV can withstand only up to 120°C. Cool the LEV while brazing.
Wire connection	<ul style="list-style-type: none"> - Connect the wire according to the wire color code to avoid miswiring. For AH500, connect two wires to the same terminal. - Do not strain the power supply wires. - Be careful with the plate edge not to damage the wire. - The wire can withstand only up to 105°C. Keep the wire away from high-temperature part. - Bend the wire into "U" shape to prevent water from running down the wire and from dripping on the electrical components or the LEV.

(5) Cautions for installing thermistor

Installation site	<ul style="list-style-type: none"> - Install the pipe thermistor properly so that it can accurately measure the pipe temperature. Protect it with the insulation material so that it is not affected by the temperature at other places. - Install the liquid thermistor sensor at the evaporator inlet where the lowest temperature is found, as the thermistor is used to prevent freezing. - Install the gas pipe thermistor at the junction of the evaporator outlet. - Install the suction air temperature thermistor at a place where the average temperature of suction air into the coil can be measured. - Install the discharge air temperature thermistor at a place where the average temperature of discharge air off the coil can be measured.
Wire connection	<ul style="list-style-type: none"> - Connect the wire according to the terminal number to avoid miswiring. - Do not strain the power supply wires. - Be careful with the plate edge not to damage the wire. - The wire can withstand only up to 105°C. Keep the wire away from high-temperature part. - Bend the wire into "U" shape to prevent water from running down the wire and from dripping on the electrical components or the thermistor.

(6) Other cautions

- The refrigerant temperature inside the evaporator may become 0°C. Note that dew condensation on AHU main body or on the refrigerant pipe may occur.
- Drain the AHU properly.
The temperature of AHU evaporator will drop and dew may condense on the AHU main body, if the LEV of AHU does not close due to malfunction in a system with one outdoor unit connected to a AHU controller, and if the AHU stopped and the other AHUs are in operation. Take appropriate measures against dew condensation to avoid serious damage to the unit.
- When a heater for heating operation is built-in and when both of the heater for heating operation and the heat exchanger are operated, the operation must be conducted within the inlet temperature range of the heat exchanger.
- Install an air filter on the heat exchanger.
- Interlock the unit with the fan to prevent the refrigerant system from running when the fan stopped.
- In a system with one outdoor unit connected to a AHU controller, the LEV of AHU will slightly open in heating operation to prevent the refrigerant from accumulating inside the AHU heat exchanger, and the temperature of the AHU heat exchanger will slightly rise.

- In a system with one outdoor unit to which some AHU controllers are connected, the LEV will be temporarily open in heating operation to run the outdoor unit in defrost operation. In this case, low-temperature refrigerant will run inside the AHU heat exchanger, and the heating capacity of AHU which is running heating operation using the heater for heating operation will temporarily drop.
- In controlling the suction/return air temperature, capacity control is affected by the outdoor temperature. When the outdoor temperature drops, the discharge temperature also drops. Take proper measures to control the room temperature, to select the outlet position, and to prevent dew condensation.
- In controlling the discharge air temperature, check the discharge air temperature of the low load capacity in middle season, because the thermostat may repeat ON/OFF. The targeted minimum capacity is 6kW. The minimum ΔT , which is the temperature difference between the inlet air temperature of the heat exchanger and discharge air temperature in heating mode, is shown as below chart. In cooling mode, ΔT is different depending on the SHF (As shown below, when SHF is 1, this is the ΔT at heating).

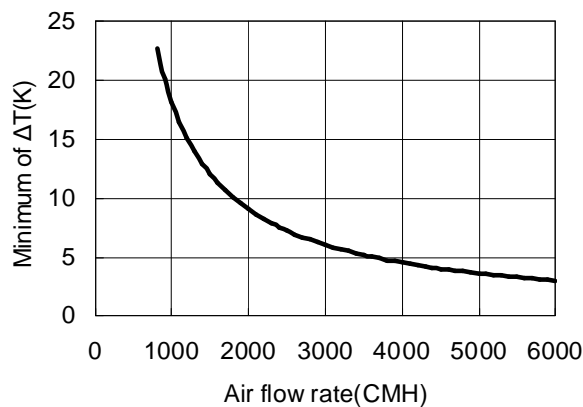

5. Requirements on interface with controller

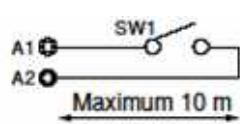
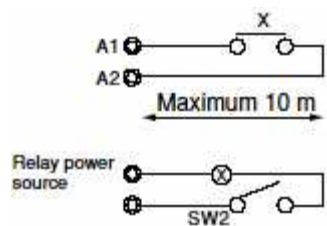
Item	Connection circuit
Operation	<p>■ Operation contact specifications</p>  <p>SW1: Operation command (field supply) Minimum applicable load DC5V, 1mA</p>
	<p>■ Use a relay when the electrical wire exceeds 10m.</p>  <p>X: Relay(field supply) Minimum applicable load DC5V, 1mA</p> <p>SW2: Operation command (field supply)</p>

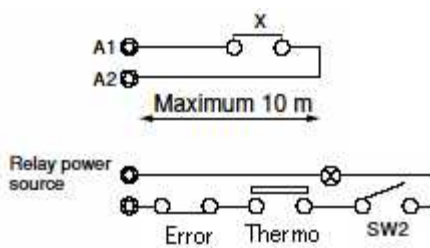
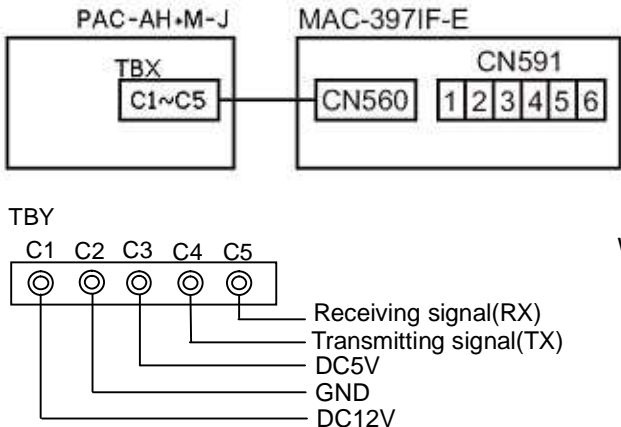
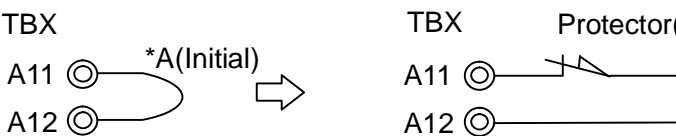
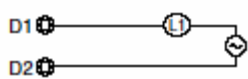
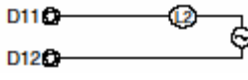
	<p>■Interlock operation with fan error and connection example of field-installed thermostat Interlock the unit so that the unit stops when an error occurs on the fan (field supply).</p>  <p>X: Relay(field supply) Minimum applicable load DC5V, 1mA</p> <p>SW2: Operation command (field supply) Error: Error of fan sections (field supply) Thermo: Thermistor (field supply)</p>
Analog input	<p>■Analog input</p> <p>TBY Wiring : AWG22~26</p> <p>B1 ⊙ ————— +DC0~10V B2 ⊙ ————— - DC0~10V</p>
Contact input	<p>■Contact input by using MAC-397IF-E</p>  <p>Wiring : AWG22~26</p>
Error input	<p>■External error input</p> <p>Remove the short circuit wire(*A) when Error input is used.</p>  <p>Wiring : AWG22~26</p> <p>Contact A11-A12 condition -Short(Initial) :Normal -Open :Error (Code 4109)</p>
Operation signal	 <p>L1: Operation display lamp (field supply) Display power source: DC30V 1A, AC100V/200V 1A</p>
Error signal	 <p>L2: Error display lamp (field supply) Display power source: DC30V 1A, AC100V/200V 1A</p> <p>If error resets (stop operation) and restart operations are repeatedly performed, the Compressor may be damaged seriously. Install an error lamp, and contact the service</p>

Insufficient powering time may result in compressor damage.

- As the temperature setting and the operation mode setting are made at initial setting, a remote controller is necessary. Remove the remote controller after making the initial settings if it is not used. In case of PAR21MAA, remove the remote controller after turning off the power of the indoor and outdoor units. In case of PAR-27MEA, remove it after deleting the address of the remote controller.

(Refer to the installation manual for remote controller for more details.)

(3) Operation control

- Remove the connector inside the AHU controller when a local remote controller is used. When the connector is connected, the controller will be in the remote operation mode, and the operation by the local remote controller will be prohibited.
- If the error lamp lights or the error display appears on the remote controller, do not reset an error by yourself. Contact the service firm or the dealer.
- Refer to the data book for system controller when using the system controller.

(4) Service

- Regular maintenance is required to prolong the life of the units. It is recommended that the maintenance contract be concluded with a maintenance firm.



7. Warranty

- Specifications of AHU and compatibility with regulations must be confirmed by your company.
- Selection of an appropriate AHU (with appropriate specifications to match those of units connected to the AHU such as configuration, dimension, life-span, vibration, noise level, or features) must be made by your company.
- Mitsubishi Electric shall not be liable for any damage to the entire system or the AHU main body caused by connected AHU with wrong specification or wrong usage of AHU.
- Mitsubishi Electric shall not be liable for any damage to the outdoor units caused by AHU damage.

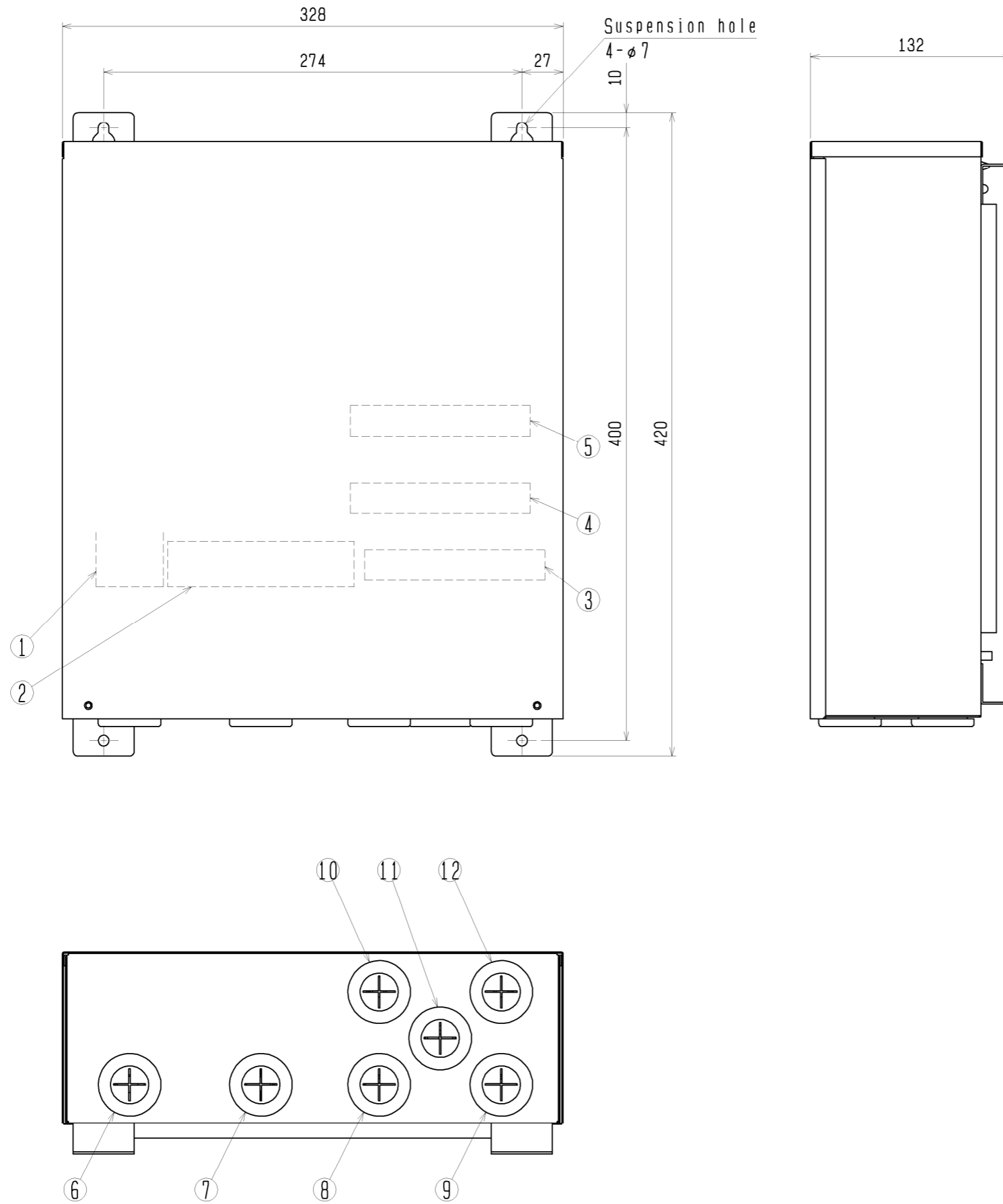
External Dimension

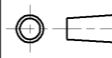

- Terminal block (Power source).....①
- Terminal block (Operation output, Error output,
Fan output, Defrost output).....②
- Terminal block (LEV).....③
- Terminal block (Distant ON/OFF input Level,
Error input Level, Thermistor).....④
- Terminal block (Transmission, Remote controller,
Analog input).....⑤
- Wiring (Power source, Earth).....⑥
- Wiring (Operation, Error, Fan, Defrost).....⑦
- Wiring (LEV).....⑧
- Wiring (LEV).....⑨
- Wiring (Distant signal, Error signal, Thermistor).....⑩
- Wiring (SPARE).....⑪
- Wiring (Transmission, Remote controller,
Analog input).....⑫

	作成日付 ISSUED	改定日付 REVISED	TITLE		
	10-04-28		EXTERNAL DIMENSIONS Model: PAC-AH125·140·250·500M-J		
SCALE NTS	 MITSUBISHI ELECTRIC CORPORATION		DRW. NO. WKD94C796	REV. *	PAGE 1/1

Electrical Wiring Diagram

NOTE

1. Initial setting of operation mode
 A remote controller is required to perform initial setting, when the controller board is exchanged.
 Remove the connector "CNRM" and set the operation mode to cooling mode. Connect the connector as it was, when the remote controller is NOT used.

2. Sign explanation

(thick dashed line): Local wiring
 ⊕: Connector / ⊙: Terminal block

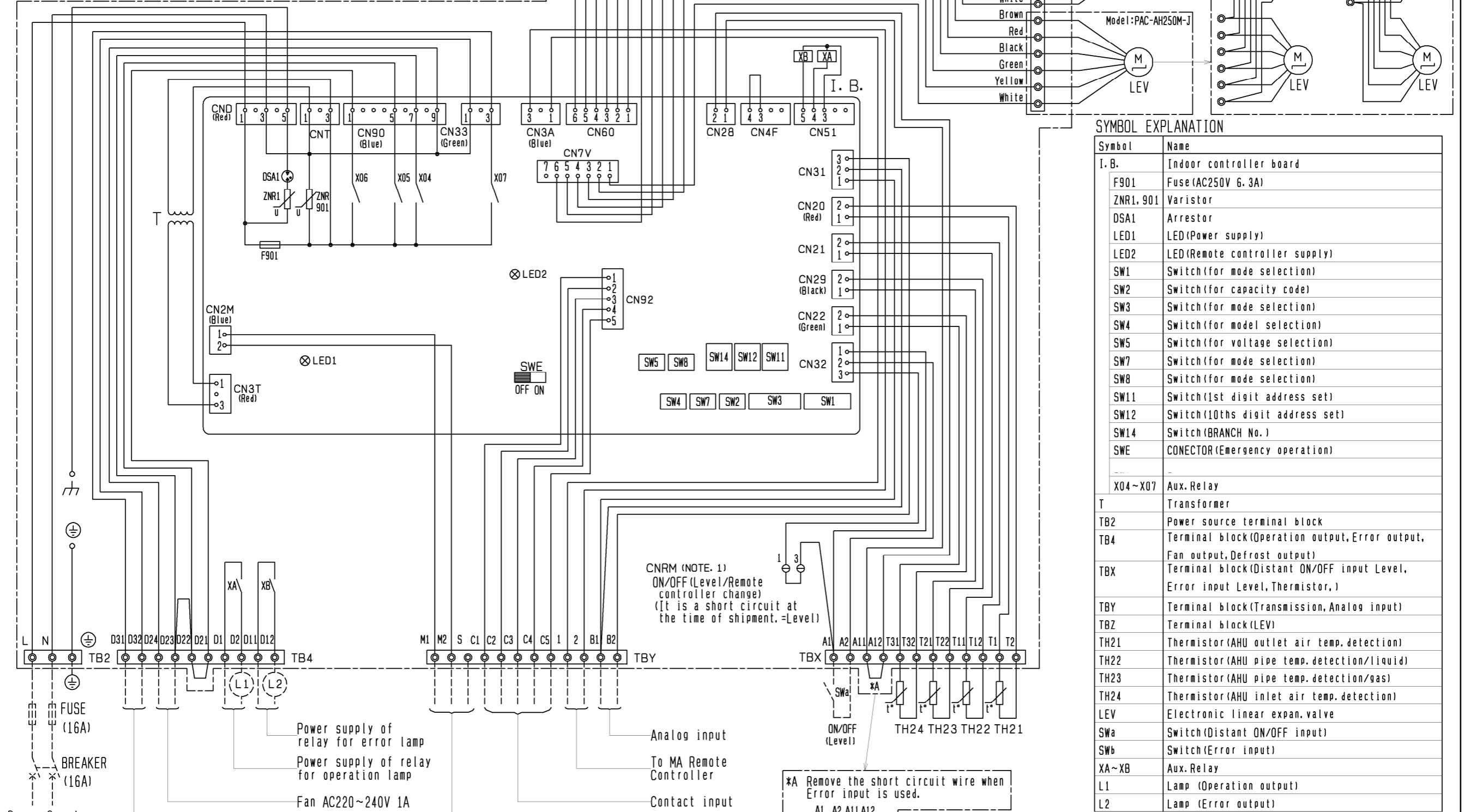

SYMBOL EXPLANATION

Symbol	Name
I. B.	Indoor controller board
F901	Fuse (AC250V 6.3A)
ZNR1, 901	Varistor
DSA1	Arrestor
LED1	LED (Power supply)
LED2	LED (Remote controller supply)
SW1	Switch (for mode selection)
SW2	Switch (for capacity code)
SW3	Switch (for mode selection)
SW4	Switch (for model selection)
SW5	Switch (for voltage selection)
SW7	Switch (for mode selection)
SW8	Switch (for mode selection)
SW11	Switch (1st digit address set)
SW12	Switch (10ths digit address set)
SW14	Switch (BRANCH No.)
SWE	CONNECTOR (Emergency operation)
...	...
X04~X07	Aux. Relay
T	Transformer
TB2	Power source terminal block
TB4	Terminal block (Operation output, Error output, Fan output, Defrost output)
TBX	Terminal block (Distant ON/OFF input Level, Error input Level, Thermistor,)
TBY	Terminal block (Transmission, Analog input)
TBZ	Terminal block (LEV)
TH21	Thermistor (AHU outlet air temp. detection)
TH22	Thermistor (AHU pipe temp. detection/liquid)
TH23	Thermistor (AHU pipe temp. detection/gas)
TH24	Thermistor (AHU inlet air temp. detection)
LEV	Electronic linear expan. valve
SWa	Switch (Distant ON/OFF input)
SWb	Switch (Error input)
XA~XB	Aux. Relay
L1	Lamp (Operation output)
L2	Lamp (Error output)

Power Supply AC220~240V 50Hz/60Hz	Power supply of relay for error lamp	Analog input
FUSE (16A)	Power supply of relay for operation lamp	To MA Remote Controller
BREAKER (16A)	Fan AC220~240V 1A	Contact input
	Defrost AC220~240V 1A	To Outdoor Unit BC Controller Remote Controller
Distant ON/OFF input		
Error input		
Analog input		
Operation output (L1)		
Error output (L2)		

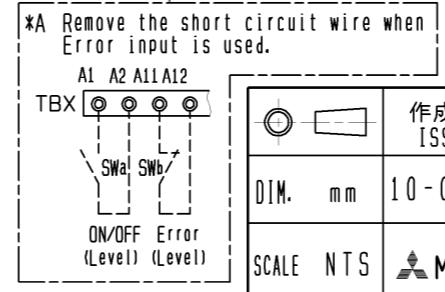

DIM. mm	作成日付	改定日付	TITLE	
	ISSUED	REVISED	ELECTRICAL WIRING DIAGRAM	
SCALE NTS	10-03-09	10-04-28	Model: PAC-AH125·140·250·500M-J	
	MITSUBISHI ELECTRIC CORPORATION		DRW. NO.	REV. PAGE
		W K D 9 4 C 8 2 8	B	1 / 1