

MITSUBISHI ELECTRIC

Air Conditioning For Building Application

Drain Water Lift-Up Kit PAC-KE04DM-F



Installation Manual

This installation manual contains only the description of how to install the Drain water Lift-Up Kit PAC-KE04DM-F. For information about how to wire and how to install air conditioning units, see the installation manual for them.

For your safety, first be sure to read "1 Safety Precautions" described below thoroughly and then install the Drain water Lift-Up Kit PAC-KE04DM-F correctly.

1 Safety Precautions

- The following two symbols are used to denote dangers that may be caused by incorrect use and their degree:

 WARNING	This symbol denotes what could lead to serious injury or death if you misuse the PAC-KE04DM-F.
 CAUTION	This symbol denotes what could lead to a personal injury or damage to your property if you misuse the PAC-KE04DM-F.

- After reading this installation manual, keep it in a place where the final user can see it anytime he or she wants to it. When someone moves, repairs or uses the PAC-KE04DM-F, make sure that this manual is forwarded to the final user.

WARNING

Always have the unit installed by Authorized Mitsubishi Representative or similar professional.
Improper installation by the user could result in problems such as water leakage, electric shock or fire.

Install the unit according to this Installation Manual.
If the unit is installed improperly, water leakage, electric shock or fire may result.

Always use the designated cables and connect them properly. When connecting the terminals, make sure that external forces from the cable is not being conveyed to the terminal and then tighten it securely.
Improper or loose connections could cause excessive heat or fire.

Have all electric work performed by a properly licensed electrician. Electric work should be performed in strict adherence to procedures to this Installation Manual. Always provide a dedicated power supply.
If the capacity of the power supply is inadequate, it could result in problems such electric shock or fire.

Only use Mitsubishi-approved accessories, such as an air cleaner, humidifier or electric heater.
Always have such accessories installed by an Authorized Mitsubishi Representative or similar professional. Improper installation by the user may result in water leakage, electric shock or fire.

Never modify the unit and always have repairs performed by an Authorized Mitsubishi Representative.
Improper repair could result in problems such water leakage, electric shock or fire.

CAUTION

PRECAUTIONS BEFORE INSTALLATION

Never use for special applications such as storing food, plants, precision equipment or art.
The quality of these items may deteriorate.

Never use the unit in special environments.
Special environments with high concentrations of oil, steam or sulfuric gases will reduce the performance of the air condition and cause its parts to deteriorate.

Never install the unit where run-off could result in damage.
If the humidity in the room exceeds 80% or if the drain becomes clogged, water may drain off of the indoor unit. When the unit is used for heating, there may be drainage from the outdoor unit. If required, provide collector drain for the outdoor unit.

Always provide adequate signal noise protection when installing in facilities such as hospitals and communication stations.
Equipment at these facilities, such as inverters, in-house generators, high-frequency medical equipment, two-way communication equipment, may cause the air conditioner to operate improperly. Conversely, the signal noise from the air conditioner may affect the operation of medical equipment and two-way communication equipment and this could interfere with the medical treatment being given a patient or cause disturbances or interference in video broadcasting equipment.

PRECAUTIONS BEFORE REMOVE AND ELECTRIC WORK

Route wiring so that there is no tension.
Tension could cause the wire to break and this could result in excessive heat or fire.

Dispose of packing materials properly.

Use care when transporting the unit.

- Always use two or more people for lifting a product weight 20 kg. or more.
- Some products are packaged with plastic wrapping bands. Never use these for lifting or transporting the product.
- Never touch the fins on the heat exchanger. They are sharp and could cause cuts.
- Never allow children to play with the plastic bags used for packaging. Always tear them up when disposing. A child could suffocate in these bags.

PRECAUTIONS BEFORE TEST RUN

Never touch the switch with wet hands.
Electric shock could occur.

Never operate the air conditioner with the air filter removed.
Particles will enter into the air conditioner and cause damage.

Never operate the air conditioner with the panel or guard removed.
The hand could come in contact with rotating, hot or high-pressure components. They could cause electrical shock or entanglement.

Never turn off the power supply immediately after stopping the unit.
Wait five minutes or more before turning off the power supply. Turning off the power supply before that time could result in water leakage or damage.

2 Confirming the Supplied Parts

1. Model names and applicable models

Model name	Applicable types
PAC-KE02DM-F	PEFY-P40VMH-A,PEFY-P50VMH-A,PEFY-P63VMH-A,PEFY-P71VMH-A PEFY-P80VMH-A,PEFY-P100VMH-A,PEFY-P125VMH-A PEFY-P140VMH-A,PEFY-P200VMH-A,PEFY-P250VMH-A

2. Provided parts

Check that the packet includes the following parts in addition to this installation manual.

PARTS	①DRAIN PUMP ASSY.	②SEPARATOR	③RUBBER PLUG
SHAPE			
QTY	1	1	2
PARTS	④CONNECTOR	⑤DUMMY CONNECTOR	⑥RUBBER BUSHING
SHAPE			
QTY	1	1	1
PARTS	⑦BAND	⑧PTT SCREW 4X10	⑨FIXING PLATE
SHAPE			
QTY	2	6 + 1(spare)	1

3 Attach the Drain Pump

The drain pump must be attached before installation of the indoor unit.

For models 40 to 140

3-1 Preparation for the indoor unit

- (1) Remove the fixing screws (2 locations) shown Photo 3-1, and remove the control box covers 1 and 2.

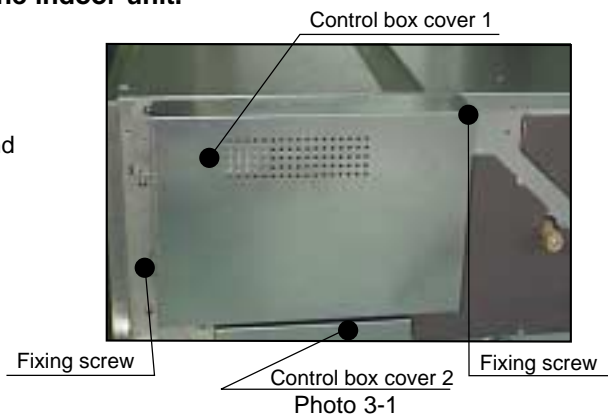

- (2) Remove the fixing screws (4 locations) shown in Photo 3-2, and remove the heat exchanger cover.

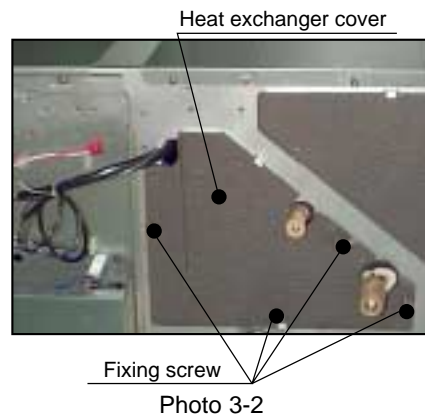

- (3) Open the knockout holes (2 places) shown in Photo 3-3 using a screwdriver etc.

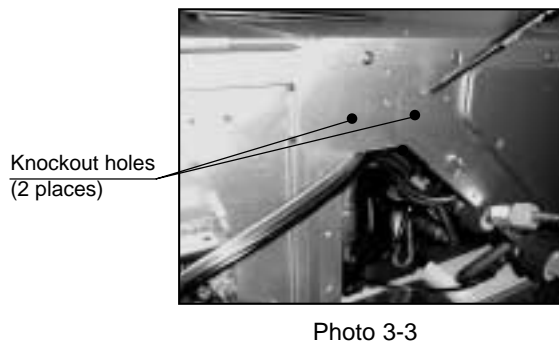

3-2. Attach the drain pump

- (1) Attach the drain pump ①, separator ② and drain socket as shown in Photo 3-4 using four PTT screws ③.
※ When attaching the drain socket, make sure that drain hose is straight.
- (2) Insert the rubber plug ③ into the drain port to close the port.
※ To prevent water leakage, make sure that the rubber plug is pushed in firmly as far as it will go.

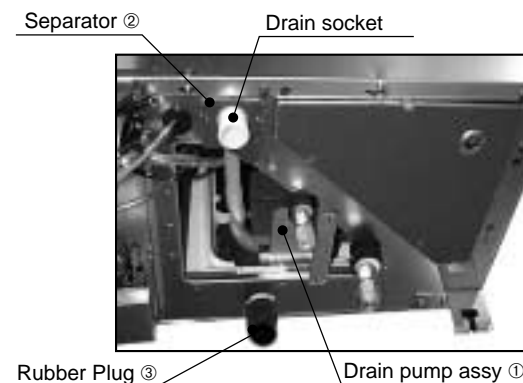

3-3. Attach the drain socket

As shown in the drawing below, insert the drain socket into the U-shaped knockout hole, and fix the frame with the separator ②. Make sure that the insulation-side of the separator faces the front.

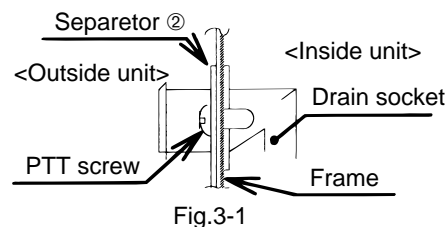

For models 200 and 250

3-4 Preparation for the indoor unit

(1) Remove the fixing screws (4 locations) shown Photo 3-5, and remove the control box cover.

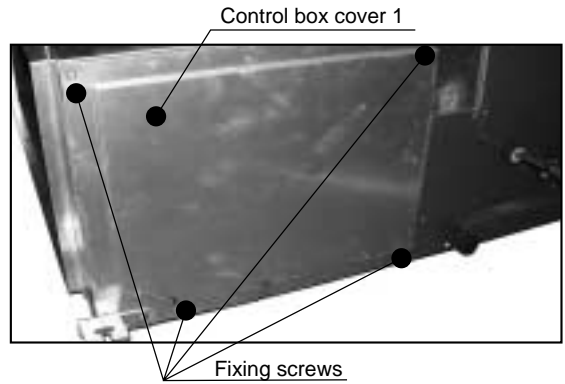

Photo 3-5

(2) Remove the fixing screws (3 locations) shown in Photo 3-6, and remove the heat exchanger cover.

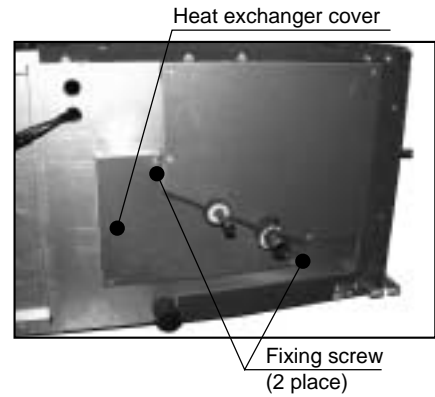

Photo 3-6

(3) Open the knockout hole shown in Photo 3-7 using a screw-driver etc.

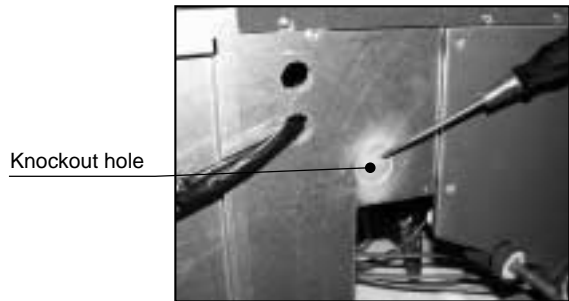

Photo 3-7

(4) As shown in Photo 3-8, remove the two screws from the drain pump ①, and attach the fixing plate ②. Also attach a earth screw as shown below.

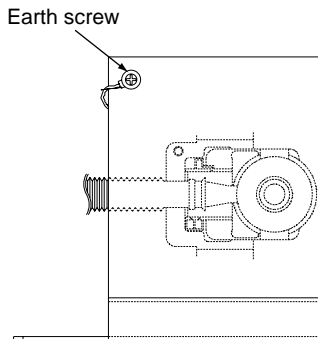

Fig.3-2

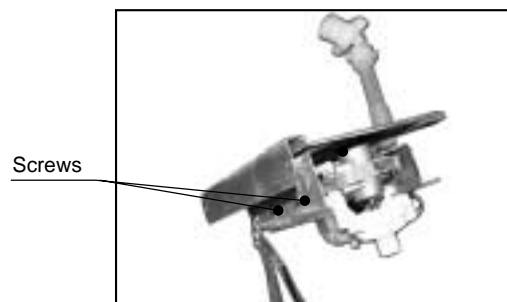

Photo 3-8

3-5. Attach the drain pump

- (1) Attach the drain pump ① and drain socket as shown in Photo 3-9 using four PTT screws ⑧.
 - ※ When attaching the drain socket, make sure that drain hose is straight.
- (2) Insert the rubber plug ③ into the drain port to close the port.
 - ※ To prevent water leakage, make sure that the rubber plug is pushed in firmly as far as it will go.

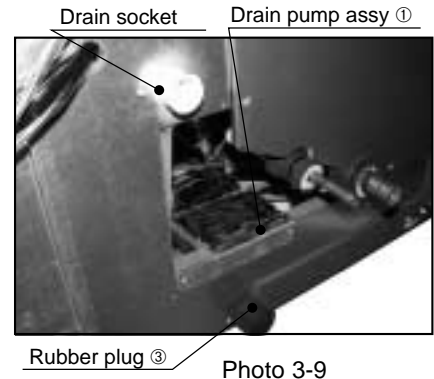

Photo 3-9

3-6. Attaching the drain socket

As shown in the drawing below, insert the drain socket into the knockout hole, and fix it with the PTT screw ⑧.

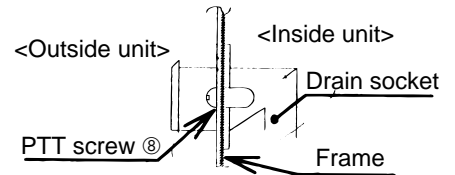

Fig.3-3

4 Wiring

For models 40 to 140

1. Passing the pump wires (Photo 4-1)

- a) Attach the rubber bushing ⑥ to the hole which was closed at step 3-1-(3), and pull the 2-wire cord (with a red and a blue connector) through the bushing.
- b) Route the 2-wire cord (with a white connector) so that it passes through the cutout when the heat exchanger cover is installed.

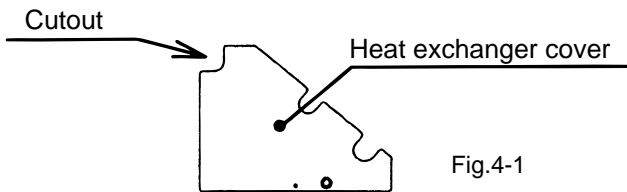

Fig.4-1

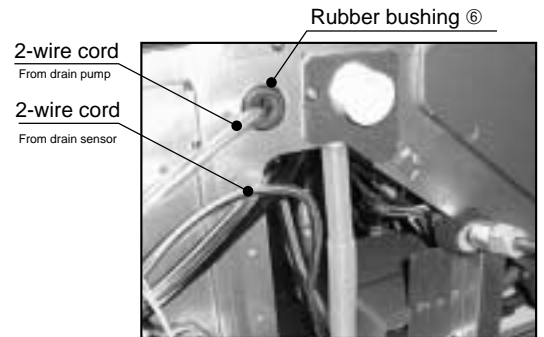

Photo 4-1

2. Connecting the pump wires to the control box of the indoor unit (Fig. 4-2)

- a) Connect the blue connector of the 2-wire cord to CNP on the indoor P.C. board inside the control box, and fix the fuse holder to the specified position (Photo 4-2) inside the control box using two PTT screws ⑧. The round solderless terminal must be connected to [L] of the power terminal block.
- b) Insert the white connector of the 2-wire cord into CN31 on the indoor P.C. board. Since a connector has been inserted into both CNP and CN31 before shipment, they must be removed.
- c) When wiring is complete, fasten the remaining cords with the band ⑦.

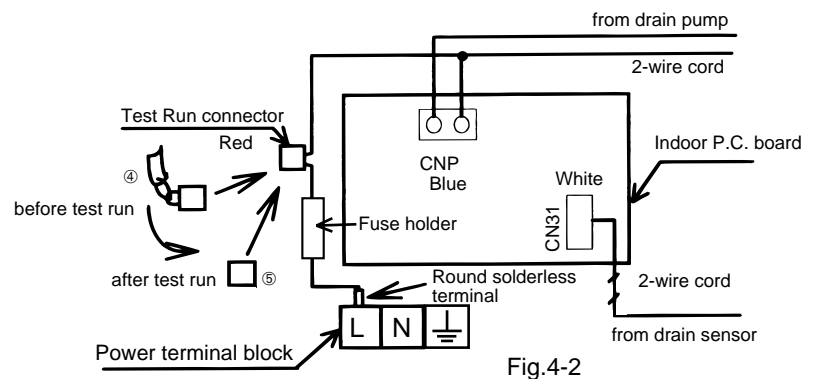

Fig.4-2

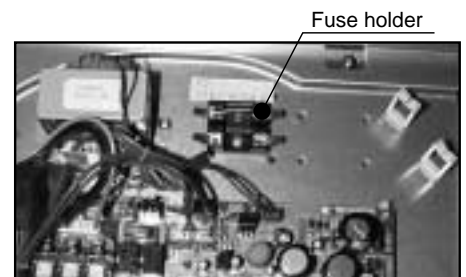

Photo 4-2

When fastening lead wires

Power wires and low-voltage wires are separated inside the control box to prevent noise. Lead wires from the Drain Water Lift-Up Kit also need to be separated, so fasten them to the lead wires located inside the control box as described below.

- Since the 2-wire cord (with a blue and a red connector) is used for power, its remaining portion must be fastened to the power transformer's primary side (white lead wire) and the lead wires from the power terminal block.
- Since the 2-wire cord (with a white a connector) is used for low voltage, its remaining portion must be fastened to the pipe sensor lead wire.

For models 200 and 250

1. Passing the pump wires (Photo 4-3)

- Pass the 2-wire cord (with a red and a blue connector) through the hole shown in the photo.
- Pass the 2-wire cord (with a white connector) through the pipe sensor and LEV lead wire hole.

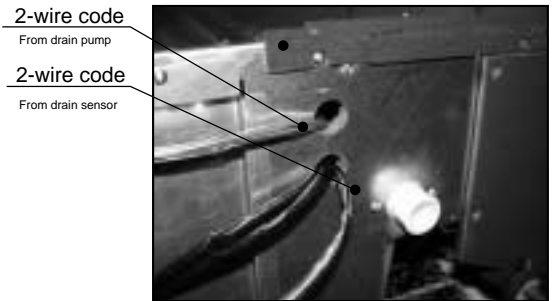

Photo 4-3

2. Connecting the pump wires to the control box of the indoor unit (Fig. 4-3)

- Connect the blue connector of the 2-wire cord to CNP on the indoor P.C. board inside the control box, and fix the fuse holder to the specified position (Photo 4-4) inside the control box using two PTT screws ⑧. The round solderless terminal must be connected to [L1] of the power terminal block.
- Insert the white connector of the 2-wire cord into CN31 on the indoor P.C. board. Since a connector has been inserted into both CNP and CN31 before shipment, they must be removed.

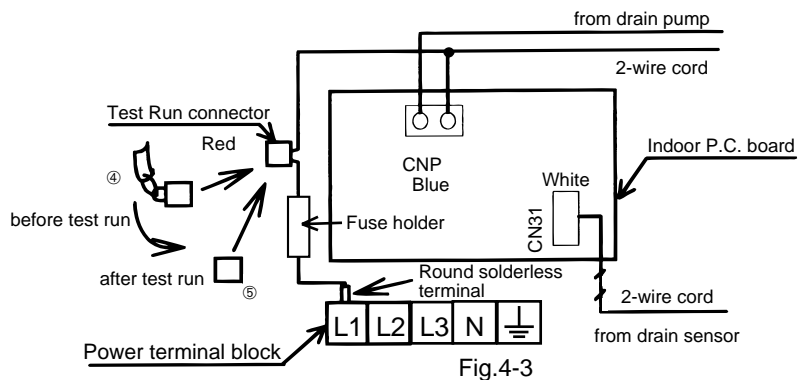

Fig.4-3

- When wiring is complete, fasten the remaining cords with the band ⑦.

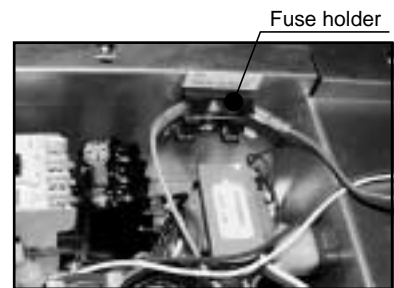

Photo 4-4

When fastening lead wires

Power wires and low-voltage wires are separated inside the control box to prevent noise. Lead wires from the Drain Water Lift-Up Kit also need to be separated, so fasten them to the lead wires located inside the control box as described below.

- * Since the 2-wire cord (with a red and a blue connector) is used for power, its remaining portion must be fastened to the power transformer's primary side (white lead wire) and the lead wires from the power terminal block.
- * Since the 2-wire cord (with a white a connector) is used for low voltage, its remaining portion must be fastened to the pipe sensor lead wire.

5 Drain piping work (common to the all models)

1. Ensure that the drain piping is downward (pitch of more than 1/100) to the outdoor (discharge) side. Do not provide any trap or irregularity on the way. (Fig. 5-1)
2. Ensure that any cross-wise drain piping is less than 20 meters (excluding the difference of elevation). If the drain piping is long, provide support bracket to prevent it from waving. Never provide any air vent pipe. Otherwise drain may be ejected.
3. Use a hard vinyl chloride pipe $\varnothing 32$ mm (1-1/4 inch) for drain piping.
4. Ensure that collected pipes are 10 cm lower than the unit body's drain port. (Fig. 5-2)
5. Do not provide any odor trap at the drain discharge port.
6. Put the end of the drain piping in a position where no odor is generated.
7. Do not insert the end of the drain piping into any sewer where sulfuric gases are generated.
8. The intake of the drain piping can be made 55 cm higher than the Indoor unit. If there are some obstacles under the ceiling, use elbows to make it at least height according to the site. (Fig. 5-3)
9. Be sure to use the supplied drain hose (Accessory). Connect each connection with vinyl chloride adhesive. But never use any adhesive over the indoor unit discharge port. Otherwise the Drain Water Lift-Up Kit cannot be serviced later. Also, the end connection may be eroded by resin and so cracked.

Note:

If the rise portion is long, there will be a lot of returned water in an operation stop, generating slime or odor during off-season. Ensure that the rise portion is at a minimum.

⚠ Caution:

Pipe the drain piping to ensure that it discharges drain, and insulate it to prevent dew condensation. A failure to the piping work may cause water leakage and so wet your property.

Fig. 5-1

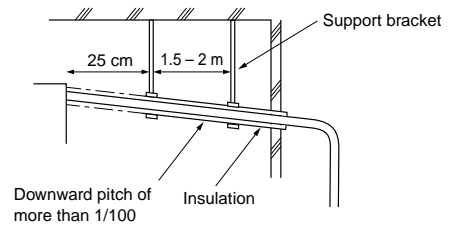

Fig. 5-2

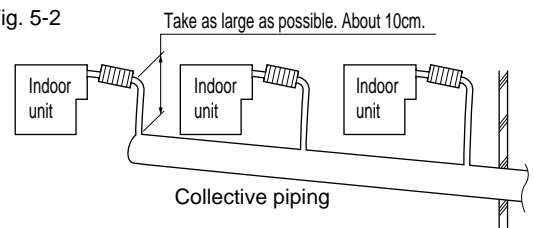
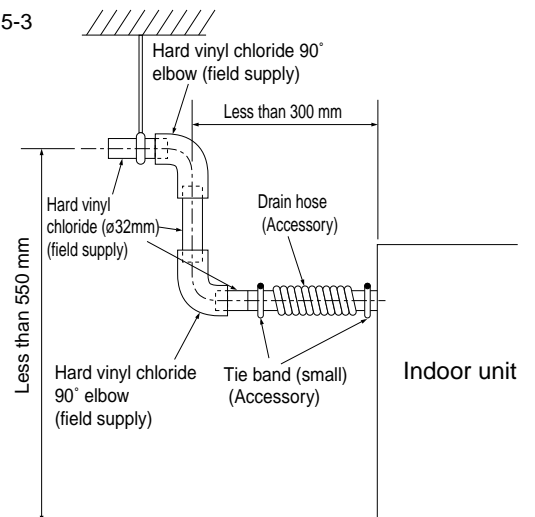

Fig. 5-3



6 Confirming drain discharge (common to the all models)

► Make sure that the Drain Water Lift-Up Kit operates normally for discharge and that there is no water leakage from the connections.

- Be sure to confirm the above in a period of heating operation.
- Be sure to confirm the above before ceiling work is done in the case of a new construction.

1. Insert the connector ④ into the test run connector (red) of the 2-wire cord of the drain pump.

2. Remove the heat exchanger cover from the indoor unit (refer to 3-1 (2):Model 40 to 140, 3-4 (2):Model 200-250).

3. Pour water into the drain pan using a kettle etc.
When pouring, make sure that the spout of the kettle is placed into the drain pan to prevent water overflowing from the drain pan.
(Photos 6-1, 6-2)

4. Turn on the main power of the indoor unit.
The drain pump will be forced to operate even if no remote controller operation is performed.
Check the transparent drain hose to make sure that drain is discharged.

5. When it is confirmed that drain is discharged properly, turn off the main power, remove the connector ④ and insert the dummy connector ⑤.

- ※ If the connector ④ remains inserted, the drain pump will be caused to operate all the time, so make sure that it is removed and dummy connector ⑤ is inserted instead.

Check that all the wiring work has been completed. If so, reassemble the drain pipe in reverse order (3-1 (2)→(1):Model 40 to 140, 3-4 (2)→(1):Model 200-250).

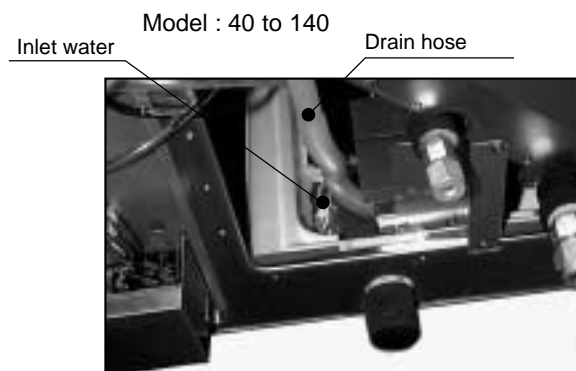

Photo 6-1

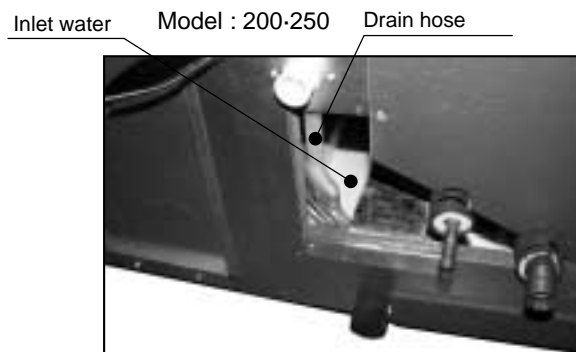

Photo 6-2